

STEALTH SERIES™

SHAFT ALIGNMENT SYSTEMS

S-680T WIRELESS 5-AXIS

- Highest Accuracy in Industry
- Win 7/8 IP65 Rugged Tablets
- 10" Outdoor Touchscreen Display
- Patented Dual-Beam™ Technology
- Duo-Plane™ Live Move Screen
- Embedded Bluetooth Class 1
- IP67 Laser/Target Housings

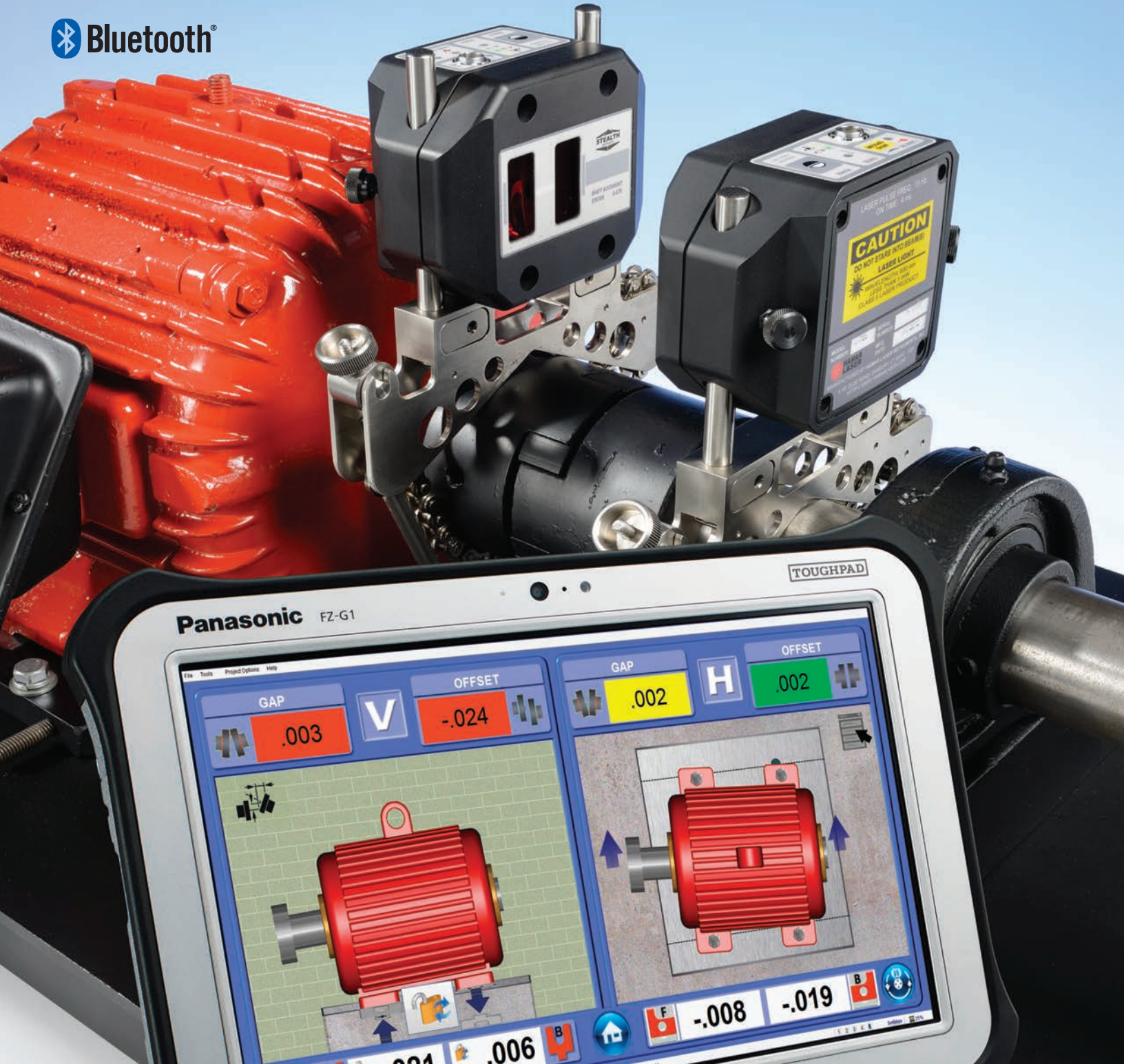

Research shows 50% of all machine downtime is the result of poor alignments

What sets the S-680T apart from the competition?

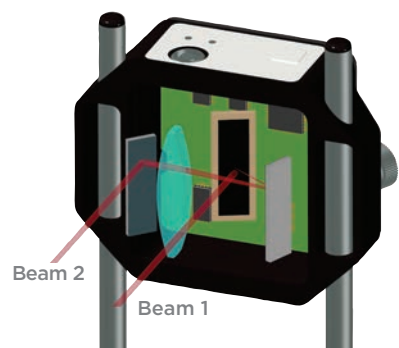

Dual-Beam™ detector technology

A patented technology that allows the measurement of offset and angle simultaneously with only one PSD, increasing accuracy by 50%.

Here's how it works:

1. Beam #1 blinks on and hits PSD measuring the center offsets.
2. Beam #1 blinks off for ambient light correction.
3. Beam #2 blinks on and bounces off one prism, passes through a lens, bounces off a second prism and hits the PSD, measuring the angle.
4. Beam #2 blinks off for a second ambient light correction.

The world's most advanced laser alignment technology

For over 45 years, we have been providing highly accurate alignment systems to many different industries and applications. We started in the machine tool industry where tolerances are high and applications are difficult, and then 20 years ago we developed the world's first 4-axis shaft alignment system. All of that experience and knowledge has gone into the design of the S-680 Wireless 5-Axis Shaft alignment system resulting in the world's most accurate and yet easy-to-use tool of its kind. You will find no better or faster system on the market to quickly and accurately align your rotating equipment.

Patented Dual-Beam™ technology reduces errors by 50%

This breakthrough technology allows you to simultaneously measure offset and angle with only one PSD sensor, which increases PSD accuracy by 50%. It also utilizes uni-directional laser beams (2 lasers, 1 direction) that make aligning machines amazingly easy, especially on long-distance applications. Dual-Beam™ technology also provides an amazing +/- 5 degrees of angular range plus an angular resolution that is 10 times higher than the highest angular tolerance. The result? More jobs done in less time. (And happier managers!)

Waterproof Bluetooth® wireless with the industry's longest battery life

With no cables to trip on or wrap around shafts, the S-680T makes for a safer work area, while giving you the freedom to go wherever you need to be - for 14 hours before recharging the battery. Our standard, Class 1 Bluetooth wireless technology offers up to 100 feet of communication range, and for wet work sites, the IP67-rated T-1290 Target can be dunked in water up to 3 feet and still transmit data!

Super linear 33x13 mm PSD detector - 0.5 Micron resolution

Laser industry's highest-resolution 2-axis, super-linear PSD sensor, providing 0.5 micron resolution and a measuring area of 33 mm (V) x 13 mm (H). Another industry best.

Duo-Plane™ live move screen for faster, easier alignments

Another exclusive feature, - the T-1290 5- Axis target allows you to simultaneously view a live alignment screen for both the vertical and horizontal planes (4 axes) without having to rotate the shafts. This is critically important on large machine applications where tightening the bolts can create horizontal movement of the machine, causing you to have to redo the alignment.

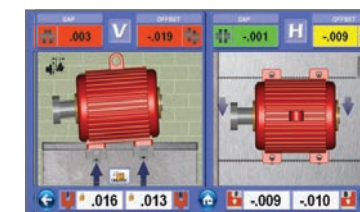

Duo-Plane™ live move screen shows live motor graphics of both alignment planes simultaneously.

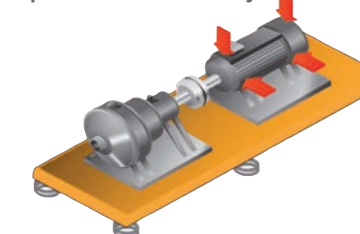

15x higher accuracy for critical machinery means fewer do-overs

Why would you trust a million-dollar piece of equipment to an entry-level, inexpensive laser? Critical machinery demands the best the industry has to offer and the S-680T up to the task. Super-linear PSD technology, 500-point linearization and the latest electronic design reduce the error rate to <0.15%, which is up to 15x higher than our competitors. Higher accuracy means more accurate shim calculations, and the confidence that when you see the green displays, the motor is aligned as accurately as possible. Higher accuracy also means fewer do-overs and faster alignments, especially on those tough alignment jobs.

Off-the-shelf software display, so replacement is never a problem

The S-680T uses familiar Windows 7 or 8 IP65 rugged tablets that are available from most computer stores. So there are no expensive, proprietary display devices to replace if broken.

Easy-Guide™ software navigation makes everyone a genius

Our Couple6 software is every bit as brilliant as our hardware, featuring our Easy-Guide™ navigation with its easy-to-follow, high-quality color screens - leading even the novice user through each stage of the alignment. And if you forget how to do something, the manual is built right into the software - compare that to our competitors' multi-page cheat sheet! With software this easy to use, training is only required for the the more complicated applications.

Stealth Series™ offers several Win 7/8, Rugged IP65 data display options with 10" sunlight-readable screens.



Bluetooth LED - Green means that the Target is connected to the computer. Blinking yellow means data is being transmitted.

On Target LED - Red means laser is blocked, green means laser is on target. Blinking green means Scanning Laser Mode (L-750).

Battery LED - Green means ok, yellow means charge.

Power/USB port - Target can be used while plugged in. Also used for data backup cable.



Why you need Stealth™ technology for long distance applications

Alignments over long distances are particularly challenging when working with a 2-laser/2-detector shaft system because it's very sensitive to small angular moves in the motor. For example, a tiny angular movement of just .0005"/in at 10 feet will cause the laser beam to move in offset by 0.060"! This makes aligning the motor's offset value very difficult to do, especially for the horizontal axis. With our Dual-Beam™, uni-directional laser technology, however, angular moves to motor do not move the laser beam at all and therefore do not affect the offset values! This means aligning the motor is amazingly easy, especially over long distances.

2 Laser-2 Detector Technology (2 lasers, 2 directions)

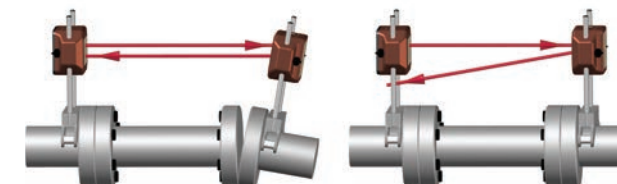

Dual-Beam™ Technology (2 lasers, 1 direction)

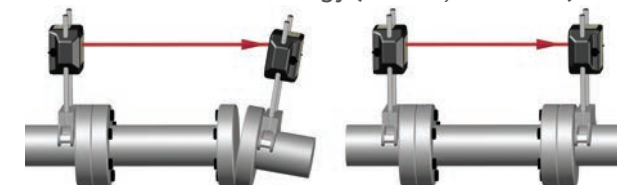

S-680T Couple6 software for tablets and PCs

Did you know that nearly 50% of the price of our competitor's lasers comes from the display box?

In any alignment system, the hardware is only part the story. The other, more important part is the software. So when we designed the Stealth™ Couple6 software, we had the novice user in mind and created our Easy Guide™ approach to navigation that is so simple to use, it requires little to no training. Easy-to-follow, high quality, color screens lead you through each stage of the alignment, so you don't need to constantly refer to "cheat sheets" just to remember how to use it!

Included Software Features

- Arc Mode™
- Auto Clock™
- Auto Sweep™
- Bolt Bound™
- Duo-Plane™ Live Move Screen
- E-mail Reports
- Flip-It™ Machine Graphics
- Horizontal/Vertical Machines
- PDF Report Generator
- Point Mode
- Repeatability/History
- Recommended Tolerances
- Report Software for PC
- Runout Data Analyzer
- Soft Foot Shim Calculator
- 7 Spacer Shaft Formats
- Templates
- Thermal Growth/Calculator
- Uncoupled Swipe™ Mode
- User-Defined Tolerances
- Vertical Machines - Live Move
- 50,000+ Saved Files

Optional Software Features

- Machine Train Analysis Software

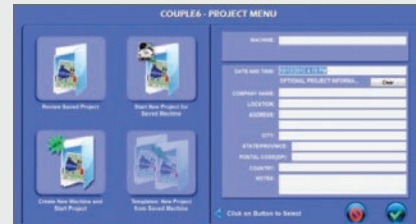

Project Menu

Start new projects, manage old alignment projects, review saved files and create project templates. Creates a unique machine folder that stores all the alignments in one place for easy historical analysis.

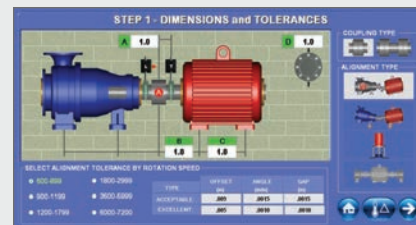

Step 1 - Machine Type, Dimensions & Tolerances

Select machine and coupling type, enter dimensions and select tolerances. Can also enter user-defined tolerances.



Step 1 - Thermal Growth Modeling

Enter thermal growth values at the coupling or the feet to offset the alignment, and the motor graphics will update to show the effects. Or enter temperature changes at the feet, select the material and Couple6 will calculate the alignment effect at the coupling. Can also be used for alignment modeling before the job starts.

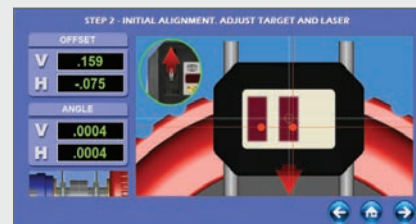

Step 2 - Laser Setup Screen

Provides live, 4-axis, raw alignment data to initialize the system and maximize measurement range. On-screen graphics show you which direction to move the laser and target during the setup. Can also be used for Rough Alignment.

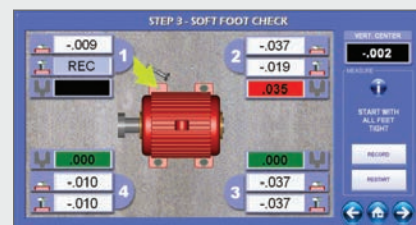

Step 3 - Soft Foot Check

On-screen, easy-to-follow procedure for checking Soft Foot, a common problem that can cause many alignment problems. Automatically selects the "problem" foot and calculates the shim to fix it.

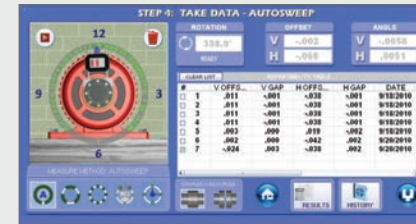

Step 4 - Measure Misalignment

Up to five data-taking modes record data for even the most difficult applications. Save multiple sets of data to check repeatability. Data can be archived and data categories assigned to track alignments.

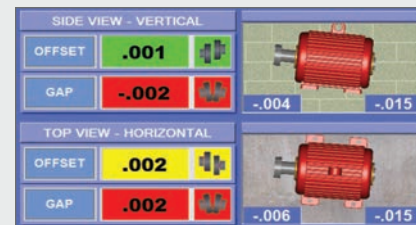

Step 4 - Measurement Results

Click on a set of alignment data to display color-code alignment results. Red means out of tolerance, yellow means "good" and green indicates "excellent". Foot values are also displayed.

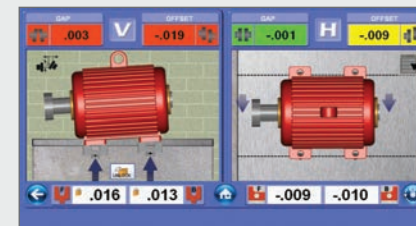

Step 5 - Live Move Screen: Motor View

Featuring our Duo-Plane™ display that shows both vertical and horizontal planes (4 axes) updating simultaneously as the motor is being aligned. When displays turn yellow or green, you're done!

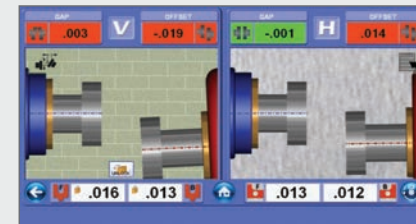

Step 5 - Coupling View

For those users accustomed to gap/offset indicator methods, the Step 5 Live Move Screen can be switched to Coupling View to show the alignment directly at the coupling.



On-demand help text

Our software manual is built right into our software, so you don't have to thumb through many pages to answer a question. Simply click "Help" from the menu, and the software will display the correct page of the manual for that screen.

Alignment Report (print or email)



To print, simply plug your tablet into a printer. To e-mail, print report to a PDF and attach to your e-mail. It's that easy.

Free Updates

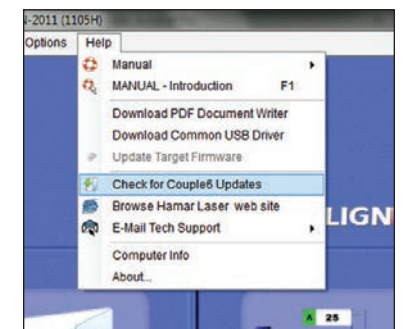

We constantly improve our software and provide free updates. Just click on "Check for Updates" and Couple6 does the work for you.

Couple6 Interactive Tour



Scan here to take an interactive tour of Couple6 on our website. Here is the link: <http://www.hamarlaser.com/app/shaft-alignment/219>

Advanced Couple6 features

More advanced features

Display Options



R-1342T Rugged Tablet
Features Windows® 8, high-resolution, sunlight-readable 10" touchscreen and an environmental rating of IP65. Runs Couple6 PC software and other HLI programs



R-1342 Rugged Laptop/Tablet
Features Windows® 7/8, high-resolution, sunlight-readable 10" touchscreen and an environmental rating of IP65. Runs Couple6 PC software and other HLI programs.

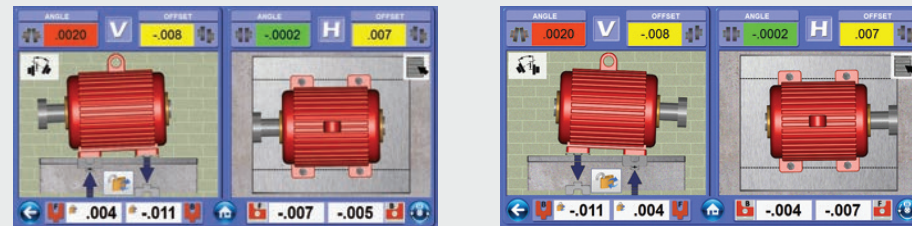

Flip It™ Feature

Couple6 allows the user to flip the motor graphics to match the pump/motor orientation without having to turn the display upside down!

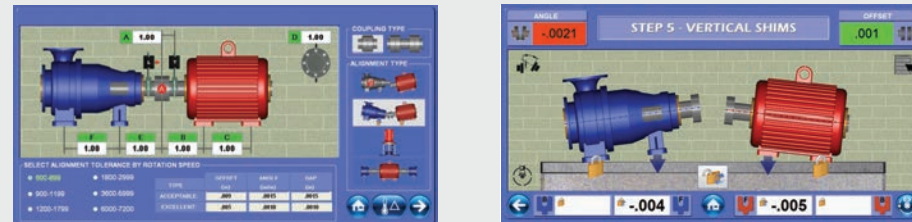

Bolt Bound™

Enter dimension of the pump, and then lock different combinations of the motor and pump feet to see how it affects the alignment. The graphics and shim values automatically update with each click.

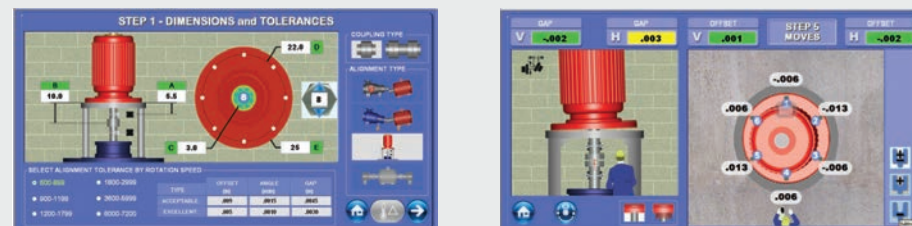

Vertical Motor Program

The industry's only vertical alignment display with live graphical displays of the motor's alignment along with shim values for all bolt-hole locations.

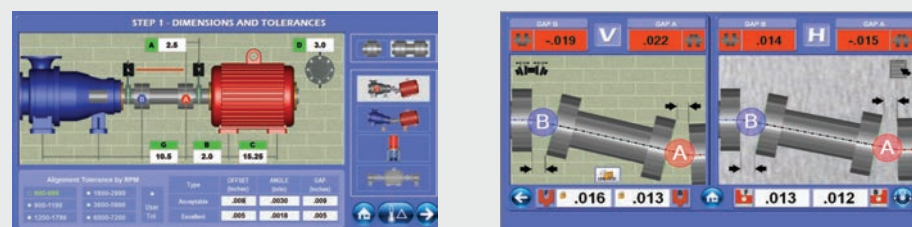

Spacer Shafts

Select Spacer Shafts, enter the spacer length and Couple6 will convert the alignment results to 7 different spacer-shaft formats.

Auto Sweep™. Simply the best data-taking method. Period.

Start rotating the shafts and the built-in accelerometer detects the movement, automatically collecting hundreds of data points. Stop rotating the shafts and Couple6 starts calculating the misalignment. More data means more accurate alignment data and less rework.

5 data-taking modes

Couple6 offers: Auto-Clock™, Auto Sweep™, Arc Mode™, Point Mode, and Uncoupled Swipe™ Mode data-taking modes for those hard-to-measure applications.

Flip-it™ screen graphics. (Why didn't anyone think of that before?)

You shouldn't have to turn your screen upside down just because you are on the wrong side of the machine. This very popular feature allows you to flip the graphics with a double-tap of the screen. No more upside-down screens and mixed-up shims.

Database management

When you create a new machine in Couple6 software, it automatically creates a folder on your tablet and then saves each new alignment file for that machine in the folder. This allows you to keep a history of alignment for each machine so you can go back and easily collect historical data for trending purposes. Each file is time and date stamped so you can save multiple copies on the same date if needed.

Geometry Add-Ons

T-1290 Target can be converted to Scanning Mode to be used with our L-730 Leveling Laser, an auto-rotating laser that is the industry's best flatness & straightness laser. Bore alignment accessories are also available along with software for most bore application. The tablet can also be used with any of our renowned geometry lasers.

"We have used the system and it really is good. It got us through the massive soft foot issues reasonably quickly, and the alignment was a breeze. The controls were simple and intuitive, and the touch screen made data entry very quick. I was able to pick it up, and align a motor accurately the first time, with very little training and no previous alignment experience. Thank you for making such an easy-to-use and accurate system."

Jeff F.
Engineer Roanoke Cement Company

Couple6 automatically saves alignment data with each click

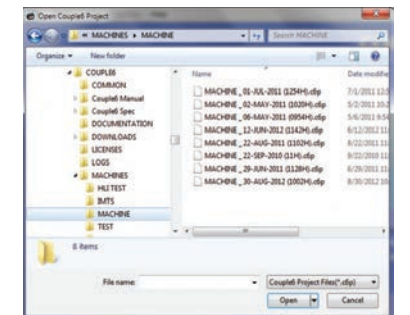

Options

Bracket & Chain Sets

A-982 Magnetic Brackets (set of 2)

A-980C Extra Chain Sets
1"-12" Shaft Diameter

A-980NRA Non-Rotating
Shaft Brackets

A-980NRB Non-Rotating
Large Shaft Bracket

A-980OF Offset Brackets

A-986 Magnetic Coupling-Flange
Slider Bracket

T-1285B Outdoor Light Filter

Geo software and accessories.

L-730 Auto-Rotating Laser
with P-R base

A-987 Flatness Measuring
Fixture for T-1285/T-1290 Targets

S-1388 Plane5 Software

Specifications

Laser/Target Unit Size	4.2" x 3.3" x 2.2" (107 mm x 84 mm x 55 mm)
Housing Material	Impact resistant plastic
Detector Type & Size	2-axis super-linear PSD 33 mm (v) x 13 mm (h) provides 4 continuously updating alignment axes (2 alignment planes).
Target Measurement Resolution	Offset: 0.5 micron (.00002") Angular: 0.007 mm/M (.00008 in/ft)
Target Measurement Accuracy	Offset: <0.15% Angular: <0.75%
Angular Sensor Range	+/- 5° (+/- .085"/inch or 8.5 mm/100 mm)
Laser Type	650 nm dual-beam laser with horizontal adjustment <0.9mW
Communication between Target & Data Analyzer	Wireless Bluetooth® Class 1 2.4 GHz plus backup cable
Wireless Range	Up to 100 feet (30 M)
Ruggedized Display Platform	IP65 tablet or laptop PC with 10" sunlight readable TFT touch screen displays
Rotation Sensor (5th axis)	Accelerometer Resolution: 0.1° Accuracy: +/-1°. Measurement accuracy not affected by rotation sensor accuracy.
Environmental	IP67 (laser & target) IP65 tablet or laptop
Data Storage Capacity	50,000+ files, limited only by hard storage capacity
Upgraded Bracket Set	Covers 1" (25.4 mm) to 12" (304.8 mm) diameter shafts. Comes with 4" (101.6 mm), 6" (152.4 mm), 8" (203.2 mm), 12" (304.8 mm) posts, two 17.25" (438 mm) chains and two 60" (1,524 mm) chains
Application Range	33' (10 M) between laser and target
Operating/Storage Temperature	5°F to 140°F (-15°C to 60°C) for Laser, Target. -4°F to 20°F to 122°F (-20°C to 50°C) for R-1342T Tablet & PC
Battery Life Target	14 hours continuous use with Bluetooth® — 15 hours with backup cable. Target can be plugged into power source during use. Battery status indicator for both T-1290 Target and PC.
Battery Life Laser	150+ hours continuous use. Blinking LED indicates low battery status.
Battery Life Tablet/PC	Up to 8 hours normal use
AC Battery Charger Laser Target & PDA)	110V to 220V with U.S. and European adapters



A-980 Bracket set

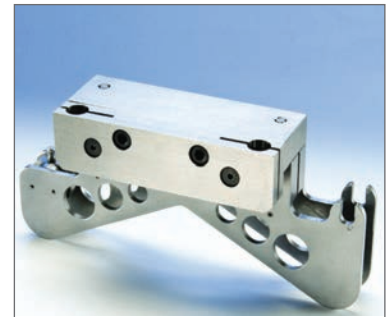

A-980OF Offset Bracket



A-980NRA Non Rotating Shaft Bracket



A-982 Magnetic Bracket

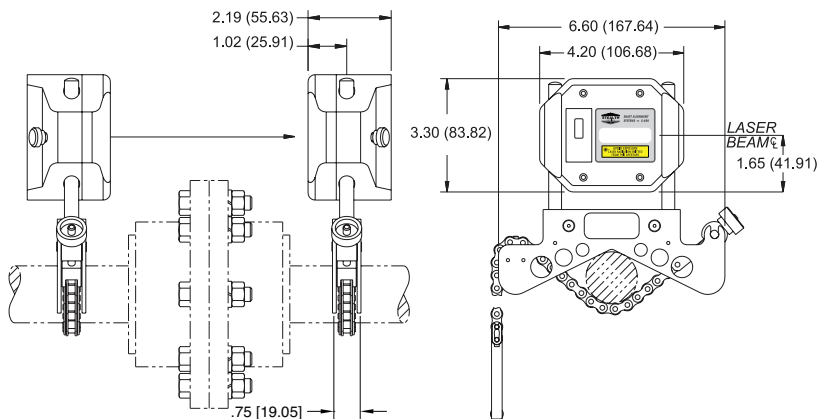

Hamar Laser Instruments, Inc.
5 Ye Olde Road Danbury, CT 06810
Phone: 800.826.6185 Fax: 203.730.4611
Int'l: +1.203.730.4600
E-mail: sales@hamarlaser.com www.hamarlaser.com