

# L-740 Series Ultra-Precision Geometry Lasers

Ultra-Precise Laser Alignment  
and Analysis Systems



# How Lasers Work — Principles of Operation

LASER is an acronym for Light Amplification by Stimulated Emission of Radiation. Lasers radiate in a single wavelength, in one direction and in a straight line, and are detected by position sensing detectors (PSDs). PSDs detect and convert the center of energy of the laser spot into a calibrated digital reading for output to a hand-held readout or computer interface.

Continuously sweeping laser planes are produced by bending a laser beam precisely 90° using an optical pentaprism. Hamar Laser applies a patented correction process to the pentaprisms to produce ultra-flat, continuously sweeping laser planes.

A laser plane is used for alignment by making it parallel (i.e. “bucked-in”) to 3 reference points or a datum plane, and using targets to measure deviations from those points. Once the laser is bucked in, any point within range of the laser system (up to 100-foot radius (30.5m)) can be aligned to the reference points. If only measurements are required, software can greatly speed up this process.

Our multi-plane lasers, such as the L-743, generate up to 3 ultra-flat laser planes and can be used with multiple targets on multiple axes to check alignment in most cases with only one setup.

For most machining centers, the process begins by simply “bucking-in” the laser to 5 reference points, 3 points using the horizontal laser plane (usually on the machine’s table) and 2 using one of the vertical planes. The 2 reference points for the vertical plane are usually chosen from either the X or Y straightness motion of the machine. The horizontal plane is measured using vertically mounted targets and the vertical plane uses horizontally mounted targets. The pitch, roll and yaw of the laser planes are adjusted by using adjustment knobs built into the base of the laser.

After bucking in, the target is moved to various points along the surface where it measures deviation from the laser reference plane. For squareness, a target is placed usually horizontally on one part of the column and zeroed. The column is then traversed up or down and any deviation becomes a measurement of squareness since the laser plane used for measuring is perpendicular to the reference laser plane.

Please visit [www.hamarlaser.com](http://www.hamarlaser.com) under How Lasers Work for more detailed descriptions.

## Powerful Data Analysis Software

Hamar’s alignment software, combined with newly designed computer interfaces, makes collecting and analyzing alignment data fast and easy. Software is Windows based, and provides large, color graphics.



**Machine Tool Geometry — Machine Setup Screen.** Choose from multiple machine configurations.

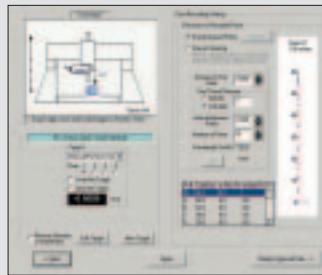

**Machine Tool Geometry — Axis Setup Screen.** Set up each line of motion for number of points to be measured.

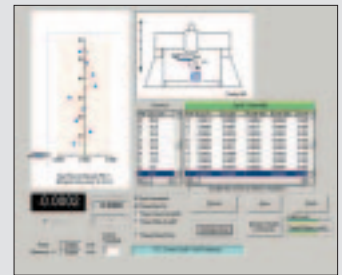

**Machine Tool Geometry — Data Taking Screen.** Records up to 10 bi-directional runs for each axis.

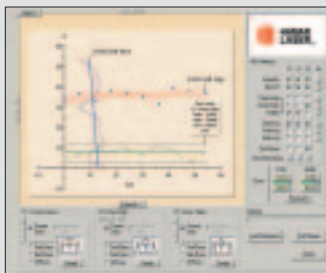

**Machine Tool Geometry — Graph Screen.** Shows axis TIRs, parallelisms and squarenesses between axes.



**Plane5 — Projects Setup Screen.** Configure shape and # of points for up to 7 surfaces.

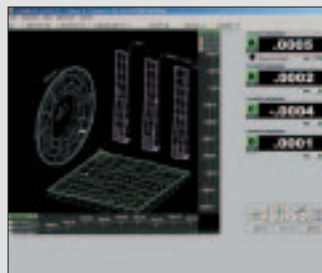

**Plane5 — Plot View Screen.** 3-D plot of surface flatness of 3 or more surfaces.



**Plane5 — Report Screen.** Complete report showing flatness, squareness and parallelism of all surfaces measured.

# L-740 Series Features and Benefits

Hamar Laser created the very first flat laser plane in 1974 and the first continuously sweeping laser plane in 1985. Today our ultra-precision L-740 Series Laser Alignment Systems represent the pinnacle of achievement in laser alignment technology.

All 4 lasers in the series produce continuously sweeping laser planes with a flatness specification of  $1/6$  arc second (0.00001 in/ft or 0.00025 mm/M). Our patented, multi-plane lasers feature 200-foot (61 meters) operating range and can measure squareness to 1 arc second (0.00006 in/ft or 0.005 mm/M). All lasers in the L-740 Series also come with 2 built-in, 1 arc-second level vials.

To detect the laser, we offer highly accurate, wireless targets that have up to 1" (25.4 mm) of measuring range and resolutions to 0.00002" (0.0005 mm). Our R-1309 wireless readout can display up to 4 targets simultaneously.

For simple and fast alignment documentation, our powerful machine geometry analysis software automatically downloads alignment data, corrects laser-slope and poor-reference-point errors and produces comprehensive alignment reports.

## All L-740 Laser Systems Feature:

- Live alignment data output for measuring and fixing alignment errors
- Continuously sweeping laser planes with  $1/6$  arc second accuracy
- Lasers planes have a range of 100 feet (30.5 m) in radius
- Wireless targets with resolutions to 0.00002" (0.0005 mm)
- Multi-plane lasers have built-in squareness measuring capability of 1 arc second
- Dimension measuring capability with target height-gage feature

## Alignment Advances from the L-740 Series:

- 50% smaller and 30% lower prices than our previous models
- Simplest and quickest squareness setup on the market
- Use multiple targets simultaneously to speed alignments
- Up to 60% faster than traditional or interferometer methods
- Collect *complete* machine geometry data on most machines, in 90 minutes or less
- Instant on with virtually no warm up

## L-740 Series Geometric Alignment Capabilities:

### Flatness (Level)

- Tables and Interrupted Surfaces
- Ways and Lines of Motion
- Way, Vertical-Column and Cross-Rail Twist
- Surface Plates
- Pitch and Roll Angular Measurements

### Squareness

- Columns to Tables or Ways
- X to Y Axis, Z to X Axis and Z to Y Axis
- Gantry Stagger

### Straightness

- Ways and Lines of Motion
- Column Travel
- Yaw Angular Measurement

### Parallelism

- Master Way to Slave
- A, B, C & W Axes to Main Machine Axes
- Roll-to-Roll
- Platen-Ram to Platen-Ram

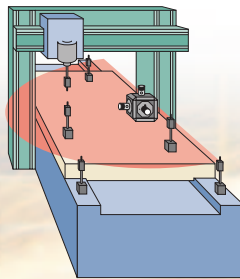

Flatness

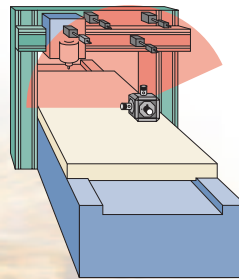

Squareness

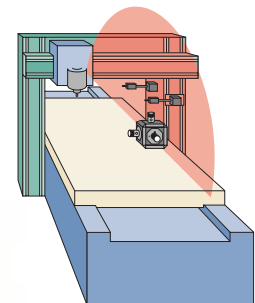

Straightness

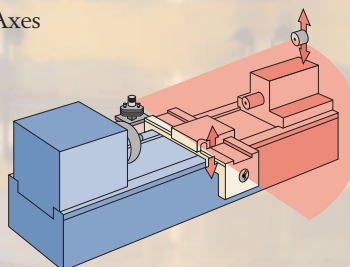

Way Flatness

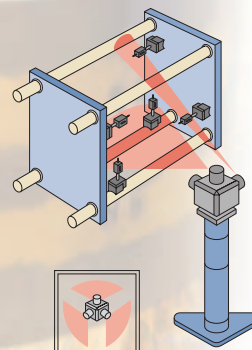

Parallelism and Tie-Bar Squareness

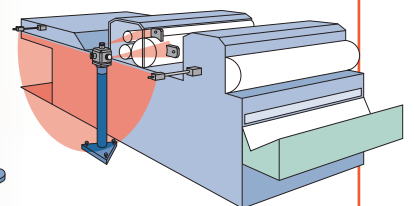

Roll Parallelism



# Multi-Plane Laser Alignment Systems for Complex, Ultra-Precise Applications

## L-743 Triple Scan® Ultra-Precision Machine Tool Alignment System

Measure flatness, straightness, and squareness simultaneously, with one setup! The L-743 Triple Scan Laser System is one of only two lasers in the world — both made by Hamar — to offer three continuously rotating highly accurate laser planes, creating a powerful tool to not only *measure* but also *fix* problems in a fraction of the time needed with conventional methods.

The L-743 laser planes are flat to  $\frac{1}{6}$  an arc second and square to 1 arc second. The laser comes with a pitch, roll and yaw adjustment base that features 1 arc-second, level vials and a powerful magnet for maximum stability. The L-743 Triple Scan Laser allows you to check the entire length of a machine's axis with one setup where every part of the machine is checked to the same coordinate system, ensuring that *all* alignment problems are quickly identified.

Designed to quickly measure and correct machine geometry with minimal setup, the L-743 can effortlessly:

- Measure flatness and straightness of bed ways or columns, and squareness and parallelism between axes, all with one setup
- Simultaneously measure parallelism in 2 axes between a master and slave way on a gantry
- Measure parallelism between rolls
- Collect data and analyze lines of motion using our Machine Tool Geometry or Plane5 Software

After the misalignment data has been collected and analyzed, you can use the L-743 to fix the errors (without changing the setup) by using our wireless targets as digital indicators.



Model L-743 Basic Package for Machining Centers

## L-742 Dual Scan® Ultra-Precision Roll Alignment System

Roll alignment has never been easier than with the L-742 Ultra-Precision Roll Alignment System. Unlike other “point and shoot” laser alignment systems, the L-742 offers two continuously sweeping, ultra-flat, orthogonal laser planes. This significantly reduces setup and alignment times, and vastly simplifies the overall process.

Add to it our wide-range wireless targets, 1 arc-second electronic level for leveling the rolls and factory-made benchmark reference fixtures, and you have a system that helps you perform roll alignments in record time. Increased system accuracy over conventional optics means your alignments will be better than ever. Better alignments mean lower scrap rates, potentially higher throughput and lower startup costs.

Innovative features like our ALIGN mode in the Cassiopeia Wireless Readout, make setting up to reference targets a much faster process.

The L-742 can easily and quickly:

- Check and correct horizontal roll parallelism of even the tallest process mills
- Pick up and check offset centerline benchmarks
- Level the rolls with our new A-700 Electronic Level
- Perform other similar alignments in record time

The L-742 is so easy to use even your most inexperienced technician can operate it. In fact, it only requires 2 days of training. Competitively priced, the L-742 is the ideal instrument for all in-house maintenance staffs.



Model L-742 Roll Alignment Package

## L-740 Series Applications

### Machine Tool Applications:

- Horizontal and Vertical Machining Centers
- Horizontal and Vertical Boring Mills
- Vertical Turning Lathes
- Large Lathe Beds
- Floor Mills



- Gantries
- Spar Mills
- Vertical and Horizontal Presses
- Transfer-Line Wing Bases
- Roll-Forming Machines
- Machine Tool Assembly and Calibration

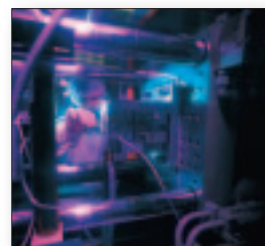

### Plastics Applications:

- Injection Molding Machines
- Film Lines
- Blown-Film Lines

# Single-Plane Lasers for Ultra-Precise Leveling and Squaring

## L-741 Ultra-Precision Leveling Laser with Plumb Beam

For those with lower budgets but high accuracy needs, L-741 Ultra Precision Level Scan Laser offers the ultimate in accuracy and affordability. The laser has a single continuously sweeping laser plane that is flat to  $\frac{1}{6}$  an arc second and a plumb laser beam that is square to the laser plane to within 1 arc second. It also features 2 backlit, 1 arc-second level vials for ultra-precision leveling applications.

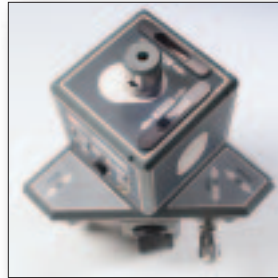

Model L-741 Laser

The system uses a combination of wireless single-axis scan targets and 2 or 4-axis, straight-line laser targets to offer simple setups and high accuracy for such applications as:

- Flatness and straightness of machine ways, surface plates and tables of most machining centers and large-bed lathes
- Straightness of Z axis in 2 axes
- Squareness of Z axis to tables or ways
- Squareness of the X and Y axes
- Parallelism of tables to ways or other minor axes to the main axes

Add our Machine Tool Geometry or Plane5 software to the system and you have a very affordable machine tool alignment package that can not only document alignment errors quickly, but also can fix those errors. The L-741 is also very portable making it an ideal entry-level machine tool alignment system.

## L-740 Ultra-Precision Leveling Laser System

The L-740 Ultra-Precision Leveling Laser is an accurate, easy-to-use flatness measuring and aligning system. It features a continuously sweeping laser plane that is the flattest in the world:  $\frac{1}{6}$  an arc second. The system comes with wireless targets that have a 0.0005" (0.013 mm), 0.0001" (0.003 mm) or 0.00002" (0.0005 mm) resolution, a Cassiopeia wireless readout that displays up to 4 targets and 1 arc-second level vials.

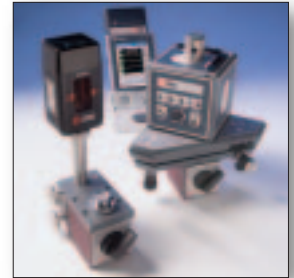

Model L-740 Basic Leveling Package

The L-740 is probably the simplest alignment tool on the market for:

- Checking the flatness of almost any surface (squares, frames, ways, flanges, circles, etc.)
- Calibrating surface plates to AAA accuracy
- Checking way twist and parallelism between horizontal surfaces
- Measuring surfaces up to 200 feet long with 1 setup

For data collection and analysis, our 3-D flatness and squareness software, Plane5, simplifies and streamlines the process. It can measure up to 7 different surfaces in one file and present a color, 3-D graph of flatness and squareness for each surface.

Taking measurements is easy: Simply level the laser, place a target on one point of the surface and zero it. Then take the target to any other point and you have a measurement of levelness relative to the zero point. To fix any errors simply put the target over an adjustment point and start turning bolts using the readout as a live digital indicator of the alignment.



### Leveling

- Split Joints On Steam Turbines
- Machine Bed Leveling

### Roll Alignment

- Paper Mills
- Printing Presses
- Continuous Casting Machines

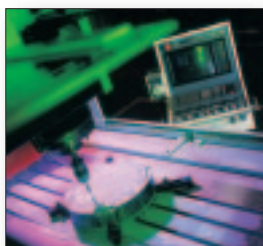

### Quality Control

- Large-Part Flatness and Straightness Checks
- Surface Plate Calibration
- Calibration of Large Fixtures and Jigs
- Checking Flatness when Scraping Ways



# Specifications

## L-743 Triple Scan Laser with Coarse/Fine Adjust Base

<b>Weight</b>	Laser: 3 lbs. (1.3 kg) Base: 4.8 lbs. (2.2 kg) Battery Pack: 1 lb. (0.45 kg)
<b>Material</b>	Laser: Aluminum and stainless steel Base: Aluminum
<b>Laser Type</b>	Class II visible diode, 635 nm wavelength (class 1 in Scanning Mode); 0.160" (4.06 mm) beam diameter
<b>Beam Power</b>	0.9 mW per straight beam
<b>Beam Stability</b>	.0001"/hr/°F (0.005 mm/hr/°C) translational 0.2 arc sec./hr/°F (0.36 arc sec/hr/°C) angular
<b>Beam Straightness</b>	0.00001 in/ft (0.0008 mm/M)
<b>Laser Plane Flatness</b>	360° Sweep: 0.5 arc second (0.00003 in/ft or 0.0025 mm/M), plus maximum translational error of +/-0.00005" (0.0012 mm) 90° Sweep: 0.17 arc second (0.00001 in/ft or 0.0008 mm/M) plus maximum translational error of +/-0.00005" (0.0012 mm)
<b>Beam/Plane Squareness</b>	3 planes mutually square to within 1.0 arc second (0.00006 in/ft or 0.005 mm/M)
<b>Operating Range</b>	100 feet (30.5 meters) in radius
<b>Operating Modes</b>	1, 2, or 3 beams and/or 1, 2, or 3 continuously sweeping planes in any combination, individually switched
<b>Power Supply</b>	9V DC external battery pack (4 cells) or 115V AC adapter
<b>Power Draw</b>	(See chart)
<b>Coarse Adjustment Range</b>	+/- 3 degrees
<b>Fine Adjustment Range</b>	+/- 0.3 degrees
<b>Fine Adjustment Resolution</b>	0.001" (0.025 mm) in 100 feet (30.5 meters)



**A-908 IR Receiver**  
Wireless data retrieval and analysis for laptops.



**R-1309 Cassiopeia™ Readout**  
Wireless, displays four targets simultaneously.



**A-1519 Hi-Res Universal Targets**  
Wireless communication with three resolution options and large measuring ranges.



**L-106 Instrument Stand**  
Lightweight, variable-height stands for flexible setup.

## L-743 Triple Scan® Ultra-Precision Machine Tool Alignment System

top view

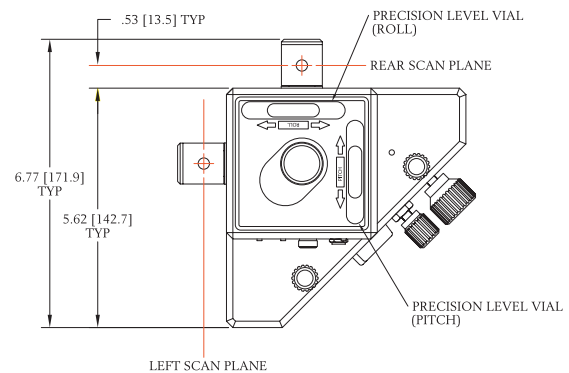

side view

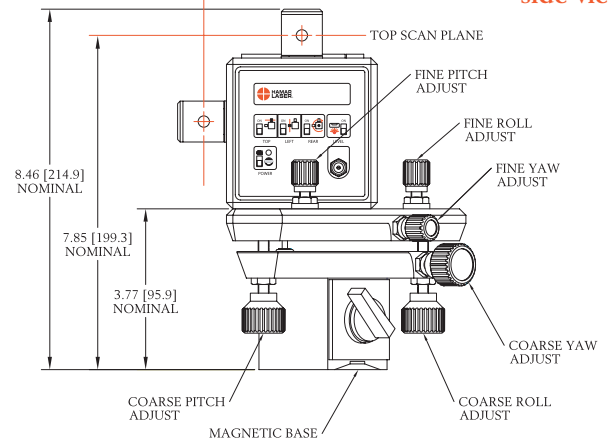

All dimensions in inches [mm]

Power Draw	Laser Only	Laser & Scanner	Battery Life*
1 Beam	100 mA	130 mA	2.5 hrs.
2 Beams	180 mA	230 mA	1.4 hrs.
3 Beams	260 mA	330 mA	1.0 hrs.

\* Per 9V alkaline battery (500 mA hrs.). Multiply battery life figure by the number of batteries used (external battery pack uses 4 cells).



**Hamar Laser Instruments, Inc.**  
5 Ye Olde Road, Danbury, CT 06810  
Phone: 800.826.6185 • Fax: 203.730.4611  
E-mail: sales@hamarlaser.com  
www.hamarlaser.com